



# i-Hot *Filtration System*

Model: EM2018

## User Guide

---

Please read this manual carefully before usage. Kindly retain for future reference.

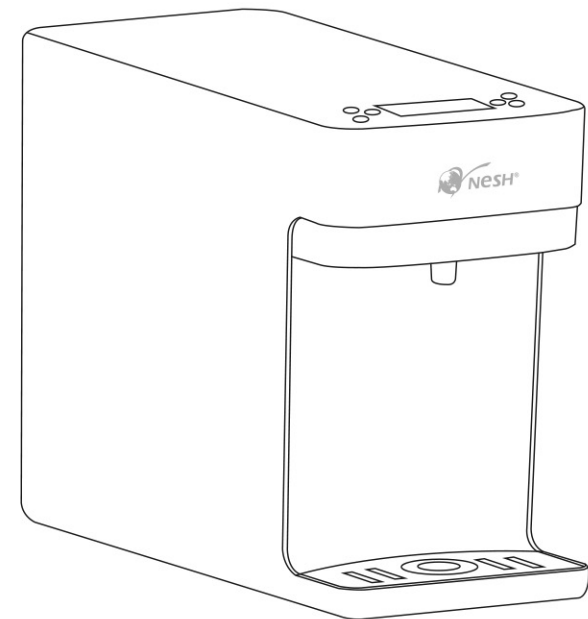

**NESH MARKETING SDN BHD**

(256765-A)

12, Jalan Puteri 4/2, Bandar Puteri, 47100 Puchong, Selangor, Malaysia.

Tel: 03-8060 3668 Fax: 03-8060 3778

E-mail: [info@nesh.com.my](mailto:info@nesh.com.my) website: [www.nesh.com.my](http://www.nesh.com.my)

## Product Introduction

### Features:

1. **Instant:** Hot water is dispensed instantly within 3-5 seconds, no pre-boil or keep warm required.
2. **Energy saving:** Operates only when heating, save energy and environmental friendly.
3. **Safety:** Instantly dispense, no re-boiling, it is safe and healthy.

Safety Precautions	.....01
Product Structure	.....03
Control Panel	.....03
Touch Key Operation	.....03
Product Usage and Maintenance	.....05
Cartridge Usage and Replacement	.....06
Limited Warranty	.....07

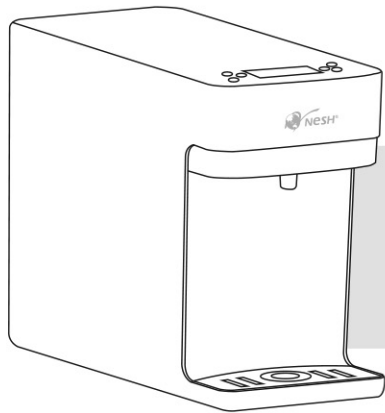

Model	: EM2018
Weight	: 5kg
Dimension	: 375 x 180 x 289(mm)
Power Consumption	: 2000W-2400W
Voltage	: 220V-240V~50/60Hz

## Safety Precautions

Please comply with the safety measures stated in this user manual for personal and property safety. Do not carry out any operation without going through thoroughly this manual.

### Icon Description



#### Warning

Operation errors may cause serious personal injury and property damage



#### Precaution

Be alert for matters related to installation, usage and maintenance



#### Instruction

Follow instructions given in the manual

## Safety Precautions



### Warning

1. Power outlet must be proper grounded 3 pin plug. The outlet current should be greater than 10A. If the product is found not proper during operation, turn off the power immediately and request professional electrician to ensure the outlet is properly grounded.
2. This product must be installed in a dry cool place, avoid direct sunlight and flammable materials. Do not place foam, cardboard or similar materials underneath the product, this is to avoid electric leakage as a result of water accumulation. This product is not suitable for outdoor use or water splashing area.
3. Do not squeeze, temper or collide the product during its transportation, installation or operation. This is to avoid product damage.
4. Hold on to the 3 pin plug instead of the power cord to unplug. Do not extend the power cord to avoid fire hazard.
5. Dry boil is strictly prohibited.
6. Do not pull the power cord when moving this product. Do not coil the power cord around the product during operation.
7. Do not place or use the product on heating surface or in high temperature area.
8. Do not touch the water outlet as to avoid burn injury.
9. Do not immerse the power cord into any liquid.
10. Make sure the power outlet has sufficient voltage capacity as to avoid short circuit. Also make sure the voltage of the power supply match the product's specification.
11. Do not turn off the water tap while in operation.
12. Place the product on firm sturdy surface and out of reach of children. Do not place the product on other electrical products.



### Precaution

1. For first use or use again after a long keep of the product, you must first dispense room temperature water before increasing the temperature.
2. Use only genuine parts for maintenance.
3. Use only soft cotton damp cloth to clean the product. Do not use cleaning products to clean the product as to avoid discoloration. Do not rinse or immerse the product in water.



### Instruction

1. Unplug the power outlet when not in use or during cleaning of the product.
2. Turn off and unplug the power outlet when there is water or electric leakage. Contact our customer service for professional technical service. Do not attempt to repair.
3. This product is a Y-shaped connection which can only be handled by professional technician. Do not attempt to repair.

## Product Structure

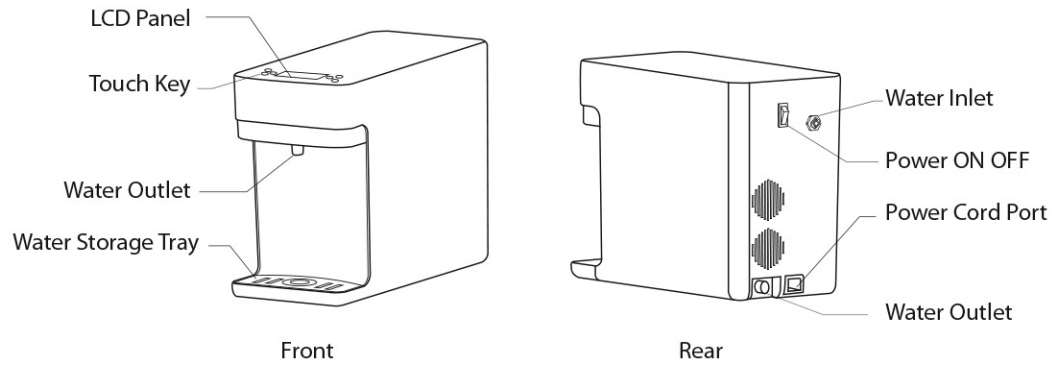



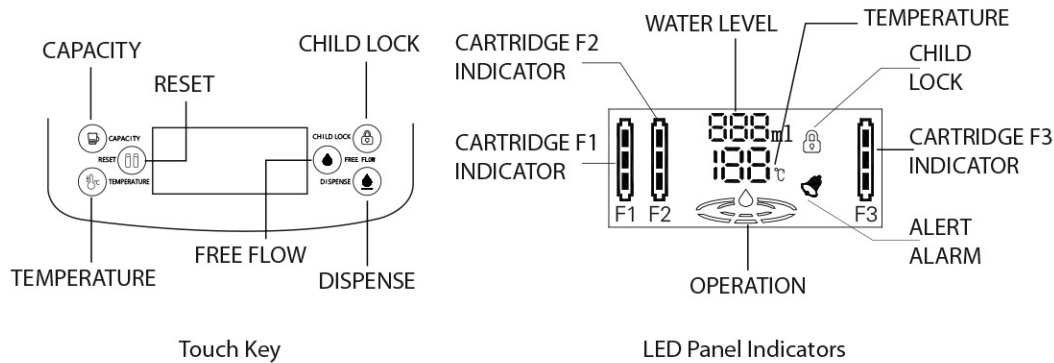

## Control Panel



## Touch Key Operation

### a CHILD LOCK

Touch , the Child Lock indicator  will light off, you may now operate the product. The product will automatically turn to Child Lock mode  if no operation after 5 seconds, Child Lock indicator  turn on. The product will not operate in Child Lock mode.

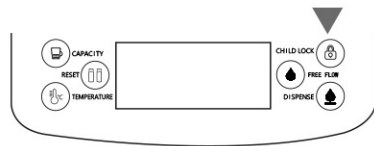

## Touch Key Operation

### b TEMPERATURE

Touch  to select from 5 choices of water temperature to meet your needs, which are 25 °C, 45 °C, 70 °C, 85 °C and 98 °C .

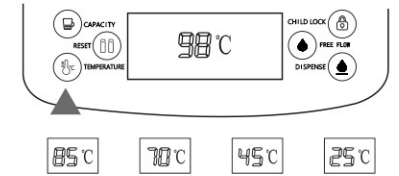

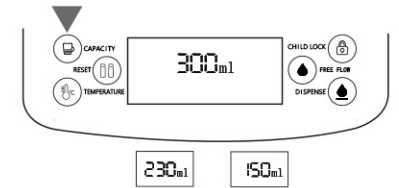

### c CAPACITY

Touch  to select from 3 choices of volume you desire, i.e. small cup around 150ml, medium cup around 230ml and big cup around 300ml.





### d DISPENSE

After selecting the water temperature and capacity, touch  to unlock, then touch  to dispense water.



### e FREE FLOW

After selecting the water temperature, touch  to unlock, touch  for free flow of water. To stop dispensing water, touch  again.



### f RESET

After replacement of cartridge, press and hold  for 3 seconds. The buzzer will ring 3 "bip", which means the expiry of the cartridge has been reset.



### 9 Separate Water and Air Flow

To ensure proper water dispensing, the water dispense outlet is equipped with separate water and air flow.



## Product Usage and Maintenance



### Warning

1. The power plug must be properly grounded and the current must be equal or greater than 10A or it may cause fire hazard.
2. Usage of the product by children and the disabled must be under proper supervision.
3. The product is a common household product, it is intended for home use only.
4. If there is fire hazard, cut off the power supply immediately and follow up with fire extinguishing action.



### Instruction

1. Dispense a glass of 25°C water whenever first use the product at any given location. This is to let the product adapt to the domestic water temperature. (Kindly peel off the protective film on the casing and water storage tray before use)
2. It is not necessary to clean the product for temporary non-use of the product (not more than 1 day).

### First Use

1. Unpack and take the product from the carton box, then install the water storage tray properly.
2. The product is in standby mode when the power supply is turned on.
3. Place a glass below the water outlet, dispense a glass of 25°C water before dispensing higher water temperature.

### Operating Instructions

1. Remove the water storage tray and the protective film on the stainless steel surface. Then put back the water storage tray to its place.
2. Use clean hands to attach the water tube to the product.
3. Plug in with dry hands. The LCD panel will light on and the product is now in standby mode.
4. Place a glass below the water outlet, it is ready to dispense.
5. Dispensing Hot Water: Select your desire temperature and capacity, after releasing Child Lock, touch DISPENSE to dispense your desire water selection. 98°C is suitable for making instant noodles, 85°C is suitable for making coffee, 70°C is suitable for making lemon drink, 45°C is suitable for making milk, 25°C is room temperature.
6. Keep the product at Child Lock mode when temporary not is use.
7. Drain off the water storage tray when needed.

## Cartridge Usage and Replacement

### 1. Cartridge Usage

- Replace Cartridge F1 when Cartridge F1 indicator fully lights off.
- Replace Cartridge F2 when Cartridge F2 indicator fully lights off.
- Replace Cartridge F3 when Cartridge F3 indicator fully lights off.

### 2. Cartridge Replacement

- Unplug, turn off the water tap, get ready to replace the cartridge.
- Unlock the cartridge that needs to be replaced from the bottom of the product, put in the new cartridge and tighten. Follow the indicator of F1, F2 or F3 accordingly to replace the cartridge.



- Press and hold RESET button for 3 seconds, the buzzer will ring 3 "bip" which means the replacement of cartridge has been successful . (Note: Only reset expired cartridge. Do not reset non-expired cartridge.)

## Limited Warranty

---

1. NESH Marketing Sdn. Bhd. warrants that this NESH product and/or its genuine NESH part/accessory is free from defects in material and workmanship at the time of its original purchase by a consumer.
2. If during the warranty period, this product fails to operate under normal use and service due to defects in design, materials and workmanship, NESH authorised distributors or service partners will at their option, either repair or replace the product in accordance with the terms and conditions stipulated herein.
3. NESH and its service partners reserve the right to charge a handling fee if a returned product is found not to be under warranty according to the conditions below.

## Terms & Conditions

1. This warranty is valid for the original proof of purchase issued to the original purchaser for this product by a NESH Authorised dealer. NESH reserves the right to refuse warranty service if this information has been removed or changed after the original purchase of the product from the dealer.
2. This warranty does not cover any failure of the product due to normal wear and tear, or due to misuse, including but not limited to use in other than the normal and customary manner, in accordance with the NESH instructions for use and maintenance of the product, nor does this warranty cover any failure of the product due to accident, hardware modification or adjustment, acts of God or damage resulting from shock and impact.
3. This warranty does not cover product failures caused by installations, modifications, repair or opening of the product performed by non-NESH Authorised personnel.
4. This warranty does not cover product failures which have been caused by use of accessories or other peripheral devices which are not NESH or NESH branded original accessories intended for use with the product.
5. There are no expressed warranties, whether in written or oral, other than this printed limited warranty.



### **NESH MARKETING SDN BHD**

(256765-A)

12, Jalan Puteri 4/2, Bandar Puteri, 47100 Puchong, Selangor, Malaysia.

Tel: 03-8060 3668 Fax: 03-8060 3778

E-mail: [info@nesh.com.my](mailto:info@nesh.com.my) website: [www.nesh.com.my](http://www.nesh.com.my)