

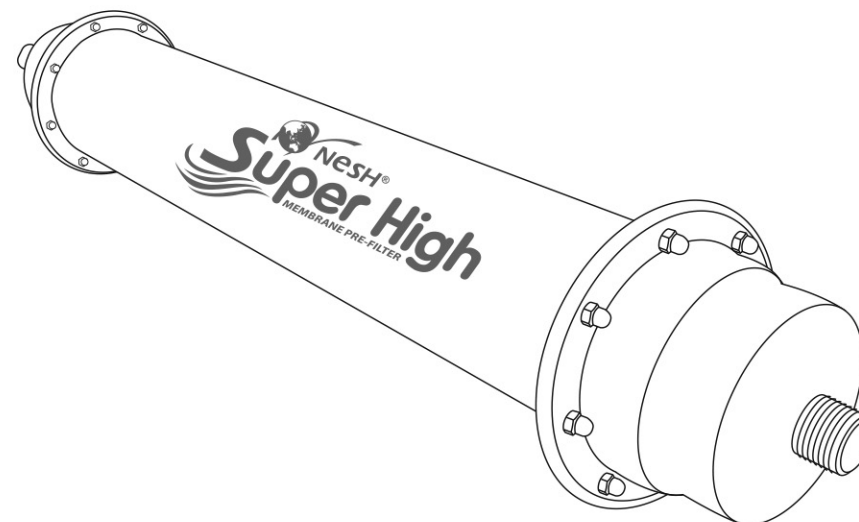

NESH Super High Membrane Pre-Filter (EM3000N)

User Guide

A complete guide for a complete NESH experience



NESH MARKETING SDN BHD

(199301002028)

12, Jalan Puteri 4/2, Bandar Puteri, 47100 Puchong, Selangor, Malaysia.

Tel: 03-8060 3668 Fax: 03-8060 3778

E-mail: info@nesh.com.my Website: www.nesh.com.my

Facebook: NESH Malaysia Instagram: neshmalaysia

NESH Super High Membrane Pre-Filter User Guide

Thank you for choosing the NESH Super High Membrane Pre-Filter!

The NESH Super High Membrane Pre-Filter is the only outdoor water filtration system that guarantees filtration purity up to 99.99%. The revolutionary technology uses 2,400 membrane hollow fibres with a density of 0.01 micron – 10,000 times smaller than an average human hair. This means that impurities and micro-organisms larger than 0.01 micron are left where they belong – outside your household water.

The membrane filter effectively removes impurities from the main water supply that goes to your home, providing your home with clean and clear water. It thoroughly removes germs, metal rust, mud and other residue inside aged piping systems. Uniquely designed with a Backwash and Flushing function, this user-friendly product promises easy maintenance and care.

Contents

In this manual, you will find useful information regarding your product including the identification of parts, installation guide, maintenance, safety tips and troubleshooting.

Safety Information02
Part/Accessory Identification03
Installation Guide04
Care & Maintenance05
Troubleshooting10
Terms of Service & Warranty12

Specifications

Height	: 748mm
Width	: 143mm
Filtration Media	: PVC Membrane
Weight	: 6.14kg
Casing	: Stainless Steel
Max Working Pressure	: < 4 bar
Min Working Pressure	: > 2 bar
Clarity	: <0.1 NTU
Clean Water Output	: 2300 L / hr
Filter Cartridge Lifespan	: > 3 years
Measurement For The Input And Output hole	: G 3 / 4

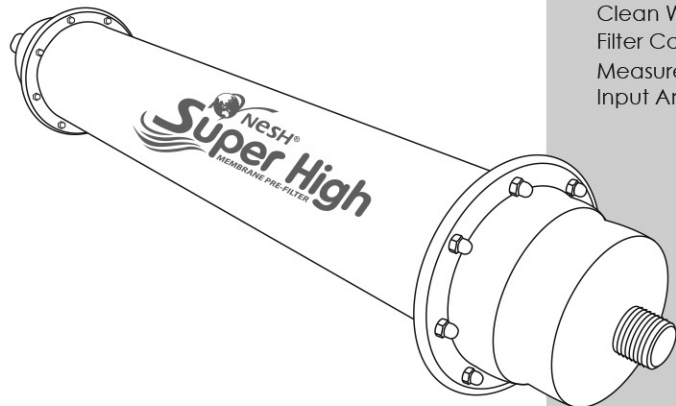

Safety Information

This chapter gives you safety information regarding your NESH Super High Membrane Pre-Filter. Please read and understand it thoroughly before installation (EM3000N).

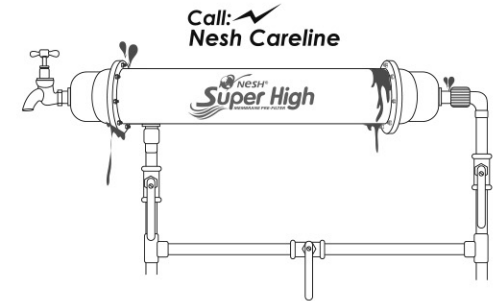
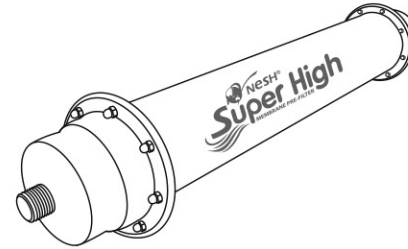

NESH Super High Membrane Pre-Filter is to be solely used on water supplies provided by utility boards and treatment plants recognised by the Malaysian government.

Do not attempt to detach, modify or repair the product from the pipes. Kindly contact our Customer Careline for assistance.

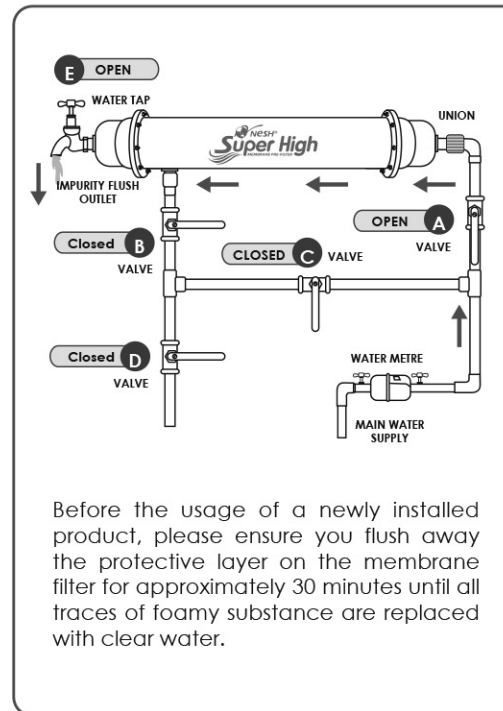

Before the usage of a newly installed product, please ensure you flush away the protective layer on the membrane filter for approximately 30 minutes until all traces of foamy substance are replaced with clear water.

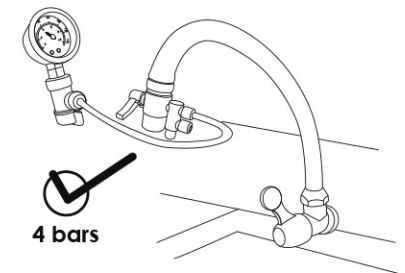

Please ensure that the maximum water pressure does not exceed 4 bars to avoid severe damage to the membrane filter. If the water pressure is lower than 2 bars, installation of a water pump is recommended.

Part/Accessory Identification

The NESH Super High Membrane Pre-Filter comes with a new range of accessories to accommodate and complete the water filtration function and process.

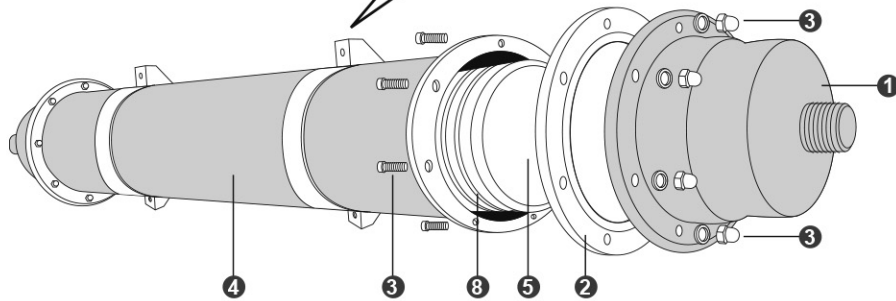
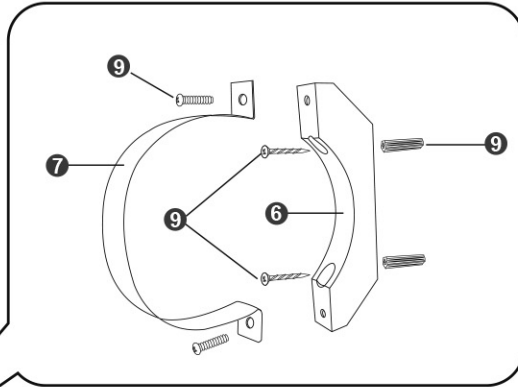

Accessories

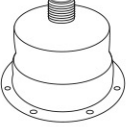
- 

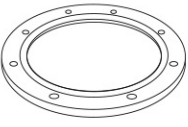
1
S/S End Cap
HW48-1
- 

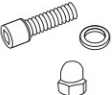
2
Gasket
R38-1
- 

3
Bolts & Nuts
HW39-1
- 

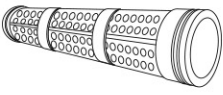
4
S/S Casing
SC01-1
- 

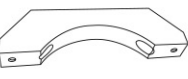
5
Cartridge
FT992-1
- 

6
Plastic Bracket Holder
R42-1
- 

7
Metal Bracket
HW42-1
- 

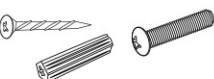
8
O-Ring
R40-1
- 

9
Screw, Wall Plug & Nuts
SP08-1

Installation Guide

- Standard Installation

1. A standard installation involves 4 valves, 1 water tap and 1 union.
2. To enjoy filtered water, please ensure that all valves are in their correct positions. Please refer to the guide below:

Horizontal Orientation

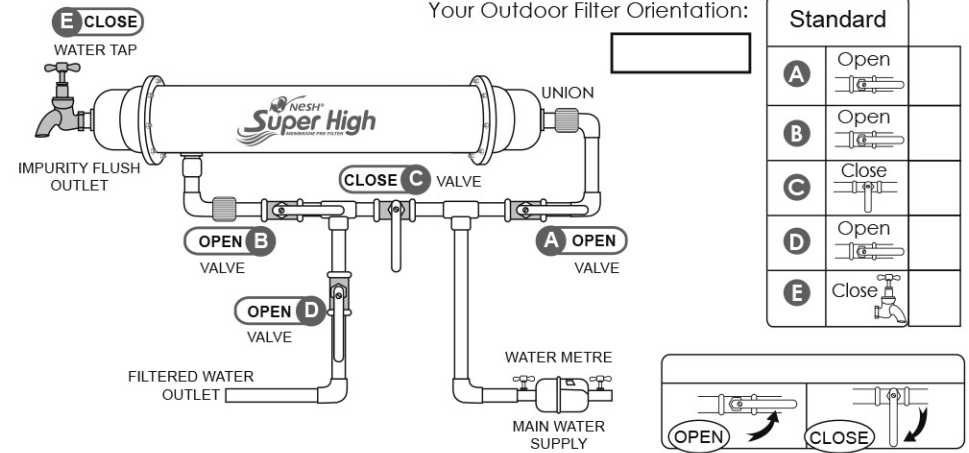

Vertical Orientation

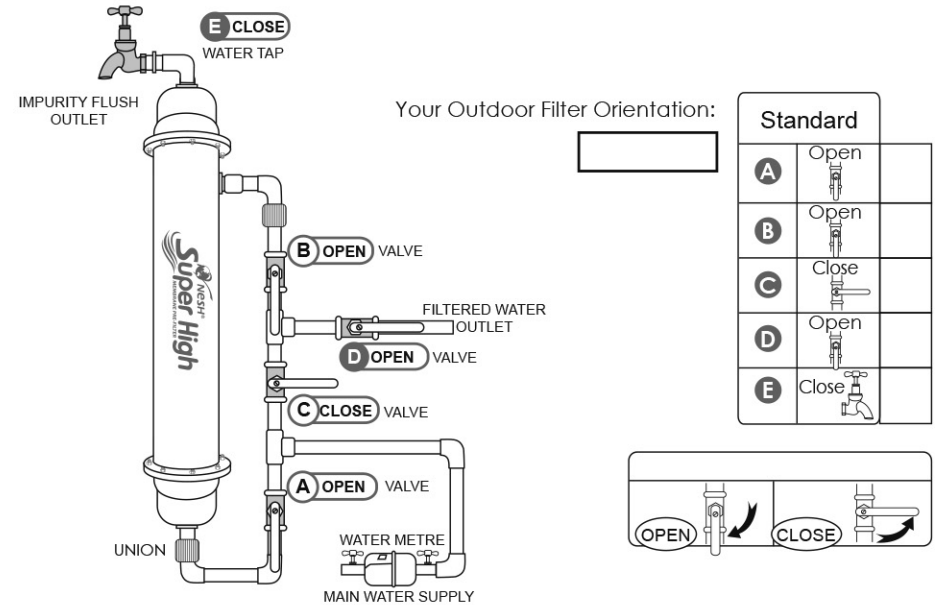

Care & Maintenance

- Cleaning Your Membrane Filter

(A) Normal Flushing (HORIZONTAL)

- Flushing involves the removal of mud, residue and impurities trapped inside the membrane filter and should be done at least **once a day**.
- Open Valve **E** to perform flushing.
Please refer to the guide below:

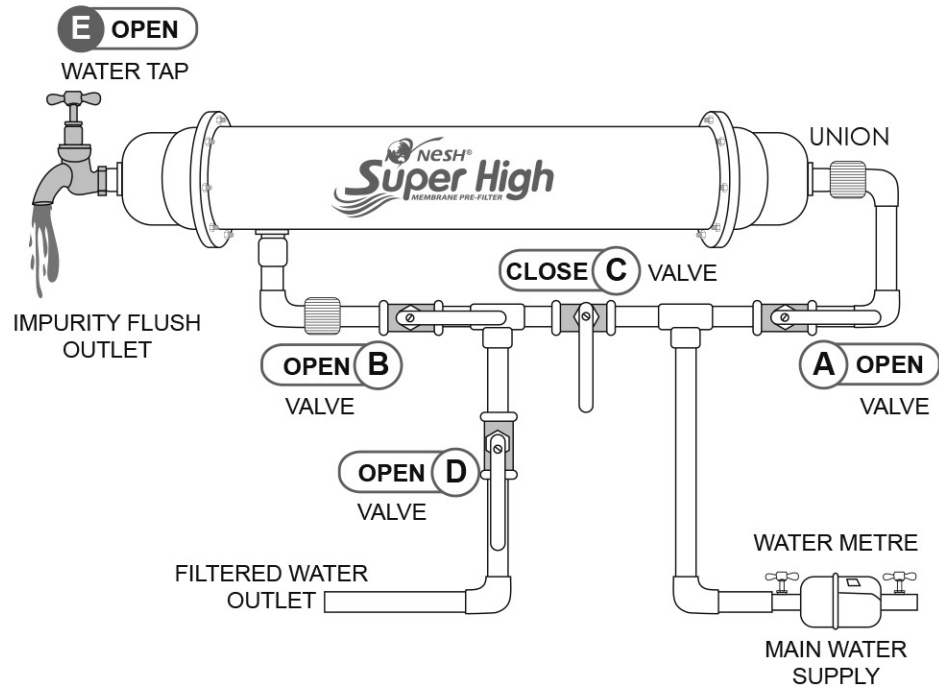

Normal Flushing (1 Minute)					
VALVE	A	B	C	D	E
	Open	Open	Close	Open	Open
					1

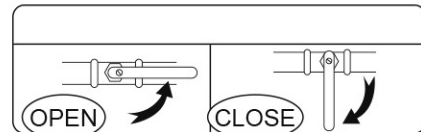

Care & Maintenance

- Cleaning Your Membrane Filter

(B) Backwash (HORIZONTAL)

Backwash involves a thorough membrane cleaning by reversing the flow of water that goes through it. This process ensures all trapped impurities between the microscopic holes of the Super High Membrane are removed thoroughly. Recommended only **once a month**. Ensure that the valves are in correct 'open/close' positions as indicated in the diagram below.

CAUTION

- After backwash, proceed to special flushing (please refer to page 5) and allow the water to run for 3 minutes for a thorough washing and to prevent impurities from re-entering the household pipes. Remember to turn the valves **A, B, C, D** back to its original position for filtered water usage. For normal usage position, please refer to Page 4.
- Backwash is only to be performed once a month. Excessive backwashing may result in a negative reverse effect as the impurities pushed back towards the membrane may lead to water blockage and membrane damage in the long run.

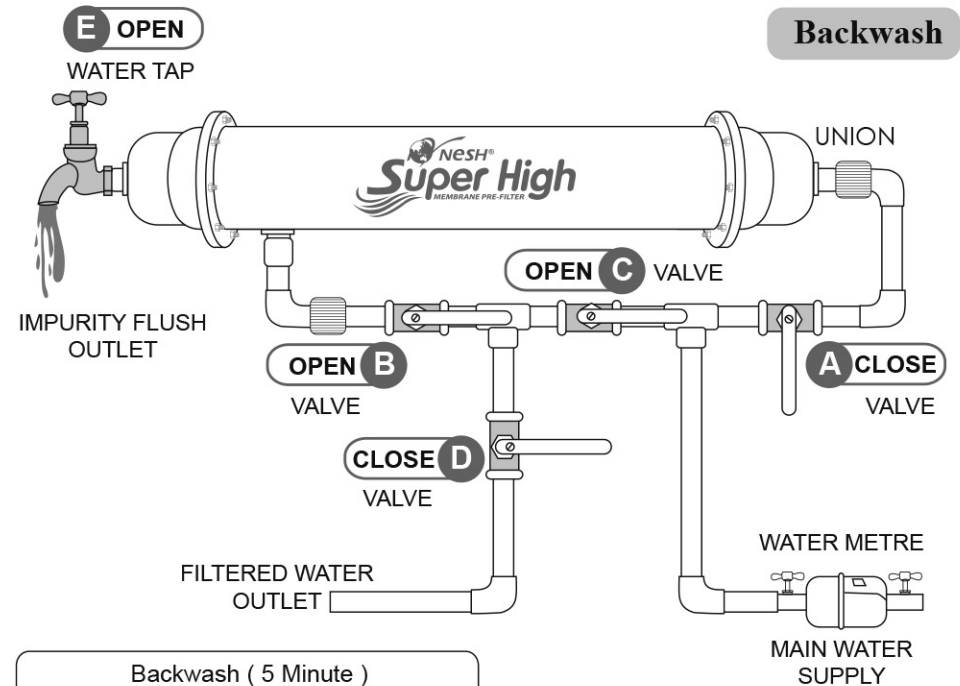

Backwash (5 Minute)					
VALVE	A	B	C	D	E
	Close	Open	Open	Close	Open
	2	4	3	1	5

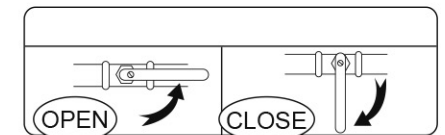

Note: After BACKWASH, proceed to Special FLUSHING (see diagram at page 7)

Care & Maintenance

- Cleaning Your Membrane Filter

(A) Normal Flushing (VERTICAL)

- Flushing involves the removal of mud, residue and impurities trapped inside the membrane filter and should be done at least **once a day**.
- Open Valve **E** to perform flushing.
Please refer to the guide below:

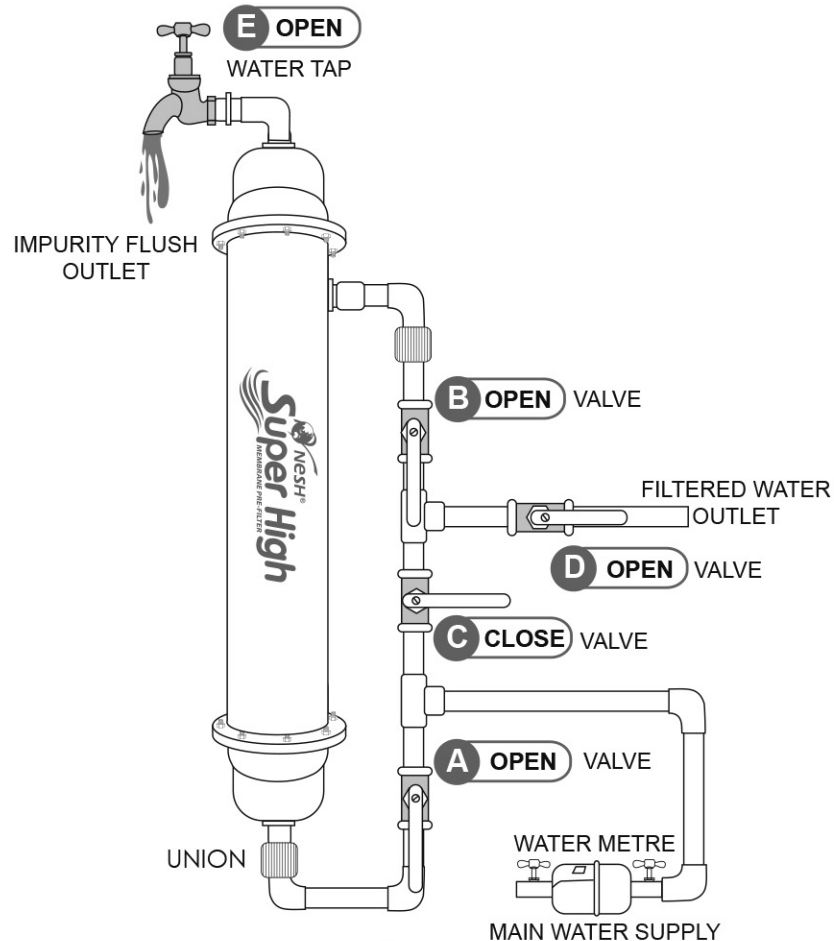

Normal Flushing (1 Minute)					
VALVE	A	B	C	D	E
	Open	Open	Close	Open	Open

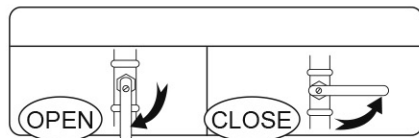

Care & Maintenance

- Cleaning Your Membrane Filter

(B) Backwash (VERTICAL)

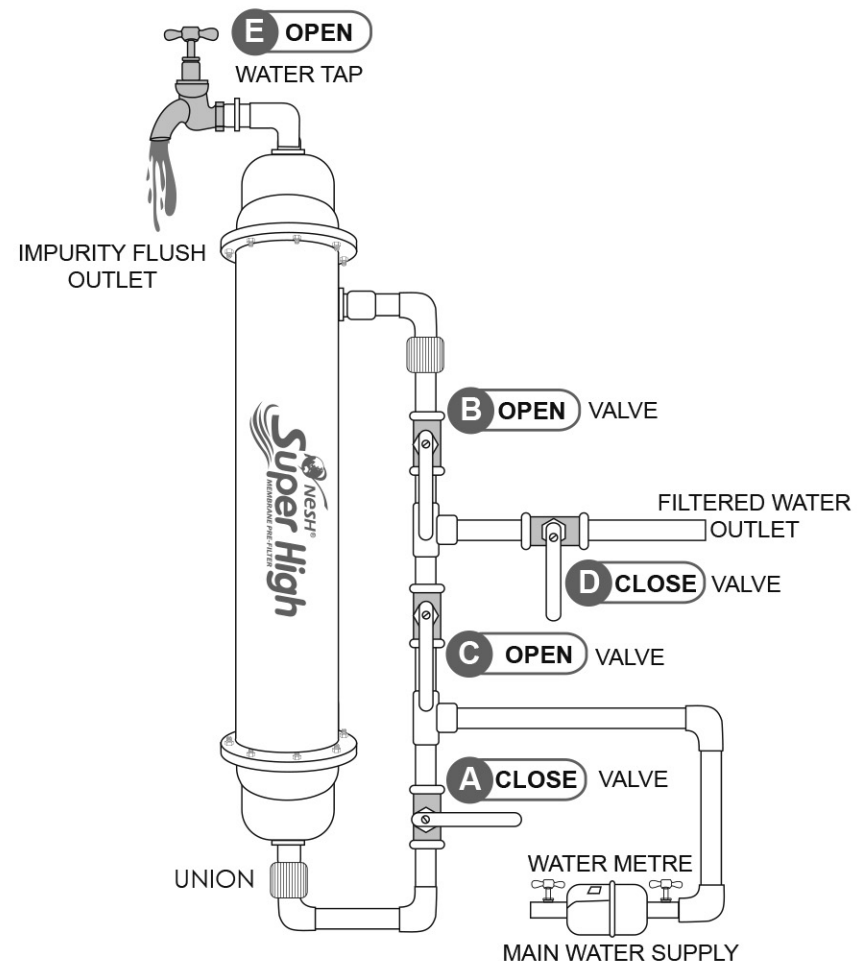

Backwash (5 Minute)					
VALVE	A	B	C	D	E
	Close	Open	Open	Close	Open

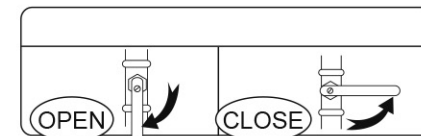

Water Bypass

- Use the water bypass position when the NESH Super High Membrane Pre Filter is removed from its piping for temporary usage of unfiltered water.
- The water bypass process is also useful in determining filter blockage and murkiness by comparing the bypass against the filtered water.
- Please refer to the guide below:

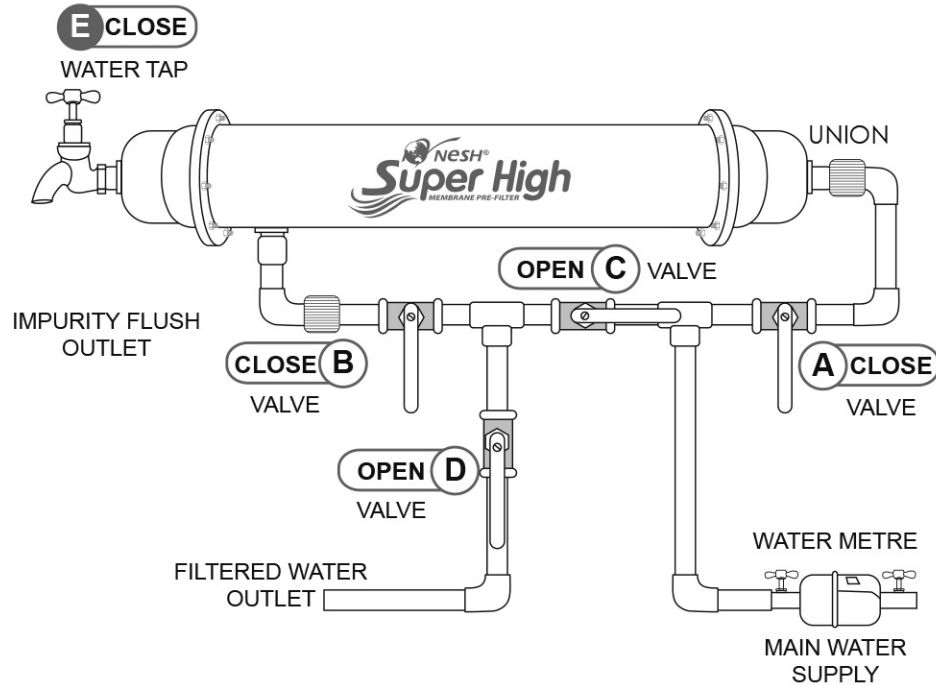

Normal Flushing (1 Minute)					
VALVE	A	B	C	D	E
	Close	Close	Open	Open	Close

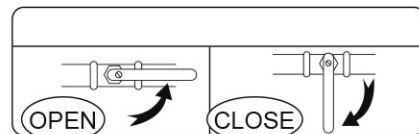

Troubleshooting

No	Condition	Possible Reason(s)	Solution(s)
1.	Leakage at S/S End Cap and S/S Plate	<ul style="list-style-type: none"> a) The bolts and nuts are not tightened properly. b) Gasket and S/S plate are wrongly installed. c) The gasket has hardened with time. d) The water pressure is too high and has caused the O-Ring to run out of position 	<ul style="list-style-type: none"> • Tighten the bolts and nuts properly. • Re-install the gasket & S/S plate. Please refer to page 3 for the standard installation guide. • Change to a new gasket. • Install a pressure reducer valve.
2.	Low water flow	<ul style="list-style-type: none"> a) Water pressure is low. b) Poor cleaning maintenance. c) In coming water from the source is contaminated with mud and residue. d) Incorrect installation. e) A, B, C, D valves are not in the correct open/close positions. 	<ul style="list-style-type: none"> • Install a water pump. Please refer to page 8 for the standard installation guide. • Perform regular flushing weekly (Refer to page 5 and 6). • Perform more flushing exercises. (Refer to page 5) or contact NESH Customer Careline for further assistance. • Please refer to Page 4 for the standard installation guide. • Please refer to Page 4 for the correct valve open/close positions.
3.	Murky or yellowish filtered water	<ul style="list-style-type: none"> a) In-coming water from the source is contaminated with mud and residue. 	<ul style="list-style-type: none"> • Perform more flushing exercises. (Refer to page 5) or contact NESH Customer Careline for further assistance.

Troubleshooting

No	Condition	Possible Reason(s)	Solution(s)
		<p>b) Incorrect installation.</p> <p>c) A, B, C, D valves are not in the correct open/close position.</p> <p>d) Rusted piping system.</p> <p>e) Poor cleaning maintenance.</p> <p>f) Membrane has expired.</p> <p>g) Water pressure is too high.</p> <p>h) Water leaking from the gasket.</p> <p>i) Usage of water from a well.</p> <p>j) Membrane is damaged.</p> <p>k) During backwash, valve D is opened.</p>	<ul style="list-style-type: none"> ● Please refer to Page 4 for the standard installation guide. ● Please refer to Page 4 for the correct valve open/close positions. ● Regular usage of the Super Membrane Pre-Filter will gradually clean the rusted pipes, or change the whole piping system. ● Perform regular flushing and once a month backwash. (Refer to page 5 and 6). ● Contact NESH Customer Careline for a new replacement service. ● Install a pressure reducer valve. ● Contact NESH Customer Careline for further assistance. ● It is recommended to filter the well water before usage of NESH Super High Membrane Pre-Filter. ● Change a new membrane. ● Close valve D.
4.	Water look clean during flushing	<p>a) Incorrect installation.</p> <p>b) A, B, C, D valves are not in the correct open/close position.</p>	<ul style="list-style-type: none"> ● Please refer to Page 4 for standard installation guide. ● Please refer to Page 4 for the correct valve open/close positions.

Limited Warranty

1. NESH Marketing Sdn. Bhd. warrants that this NESH product and/or its genuine NESH part/accessory is free from defects in material and workmanship at the time of its original purchase by a consumer.
2. If during the warranty period, this product fails to operate under normal use and service due to defects in design, materials and workmanship, NESH authorised distributors or service partners will at their option, either repair or replace the product in accordance with the terms and conditions stipulated herein.
3. NESH and its service partners reserve the right to charge a handling fee if a returned product is found not to be under warranty according to the conditions below.

Terms & Conditions

1. This warranty is valid for the original proof of purchase issued to the original purchaser for this product by a NESH Authorised dealer. NESH reserves the right to refuse warranty service if this information has been removed or changed after the original purchase of the product from the dealer.
2. This warranty does not cover any failure of the product due to normal wear and tear, or due to misuse, including but not limited to use in other than the normal and customary manner, in accordance with the NESH instructions for use and maintenance of the product, nor does this warranty cover any failure of the product due to accident, hardware modification or adjustment, acts of God or damage resulting from shock and impact.
3. This warranty does not cover product failures caused by installations, modifications, repair or opening of the product performed by non-NESH Authorised personnel.
4. This warranty does not cover product failures which have been caused by use of accessories or other peripheral devices which are not NESH or NESH branded original accessories intended for use with the product.
5. There are no expressed warranties, whether in written or oral, other than this printed limited warranty.

Notice

1. The lifespan of the product may vary from case to case depending on the maintenance, water quality and conditions, usage frequency and capacity. The product warranty is as below:
 - Piping : 3 months
 - Super High Membrane Pre-Filter & Spare parts : 1 year
2. Do not disassemble the product at any time without our professional assistance, otherwise it will be considered as tempered.
3. Use only NESH genuine parts.
4. Engage only NESH authorised technician. NESH will not be responsible for damage done by unauthorised personnel.